



Prestel KB-IP11



Video Conference Controller



USER MANUAL

Statement

Thank you very much for purchasing our products. Please be free to contact us if there is any questions or requirements. The purpose of this manual is to ensure that the user can use the product correctly to avoid danger or property damage during operation. Before using thence and futures product, please read it carefully and keep it for future reference.

The contents described in this manual maybe different from the current version you used. If you have any questions , please do not hesitate to contact us to get technical support. This user manual will be updated from time to time and we reserves the right without notice.

1. Product Overview

1.1 Brief Description

This controller enjoys strong functions, which effectively solves the problem of inconvenient operation of video conferencing camera on web pages. High-end atmosphere, the unique surface hardening can effectively prevent scratches; the industrial-grade blue screen LCD module had excellent display effect, and the characters are delicate and clear. It supports PELCO, VISCA, ONVIF , VISCA IP, NDI protocols in default. The built-in web server realize the perfect control of the video conference camera.

1.2 Product Features

- (1) Extensive protocol support : VISCA , PELCO D/P , ONVIF , VISCA over IP.
- (2) Cross-protocol mixed control via RS232/RS422 and IP.
- (3) Quick access to key camera functions.
- (4) Variable speed four-dimensional joystick control.
- (5) Independent wide-range dual power input: 12V DC, PoE

1.3 Product Functions

- (1) The controller supports serial RS232, RS422/485 and IP hybrid control.
Allows use of RS232/RS422/485, IP Control cameras in single system.
- (2) Through IP control, the controller can automatically search for IP cameras
- (3) An unlimited number of controllers can operate on a single network, controlling
- (4) The imported four-dimensional joystick with variable speed is used for control, which feels comfortable and good. Twisting the joystick can directly control the rotation of the conference camera. Zoom in and Zoom out , and the speed can be controlled according to the strength of the joystick control , and the speed and rhythm can be controlled at will.
- (5) Use the rocker switch to adjust the zoom of the conference camera, which is easy to operate and powerful.
- (6) Support IE browser to add and configure front-end equipment parameters.

(7) Up to 6 camera shortcut control buttons, convenient and quick operation of conference video cameras.

(8) Independent wide voltage dual power input:12V DC, PoE

1.4 Control Mode (Three Networks and two Analogs)

Five control protocols are supported: network (ONVIF, IP VISCA , NDI) emulation (PELCO, VISCA).

2. Product Interface Description

2.1 Interface Description

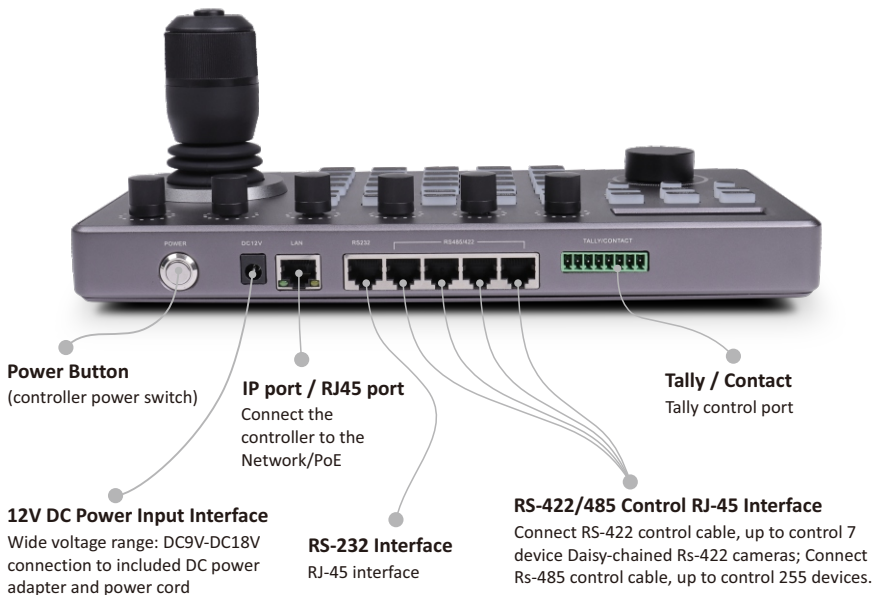

3. Button Function Description



3.1 Functional Button Description

Camera Function Section

HOME:	Home	MENU ON:	Menu On
AUTO EXPOSURE:	Auto Exposure	MENU OFF:	Menu Off
EXPOSURE CYCLE:	Exposure adjust Auto	MENU ENTER:	Menu Confirm
AUTO WHITE BALANCE:	white balance White	MENU BACK:	Menu Back
WHITE BALANCE CYCLE:	balance adjust	NEAR:	Focus +
BACKLIGHT ON:	Backlight on	FAR:	Focus -
BACKLIGHT OFF:	Back-light off	AUTOFOCUS:	Auto focus

Knob Function Section

IRIS/SHUTTER:	Aperture/Shutter adjust
R GAIN:	Red gain + -
B GAIN:	Blue gain + -
FOCUSSPEED:	Focus speed adjust
PRESETSPEED:	Preset speed adjust PT
ZOOM SPEED:	speed adjust Zoom speed
JOG KNOB:	adjust Zoom + -

Controller Functional Button

SETUP:	Set, Controller native settings
CALL PRESER:	Call preset
CAM ID:	Cameras address
ESC:	Exit
ENTER:	Confirm
NUMBER0-9	Number Key, IP, Preset Etc use







Shortcut Function Section

CAM1-7: 1-7 Cameras Switch Button

F1-F2: Custom hexadecimal command buttons

Keyboard Setup	Decription	
1. Add IP Device	Can add: Onvif, Visca over IP(TCP / UDP)	
2. Add Analog Device	Can add: Visca, Pelco(D / P)	
3. Switch Controller Mode	Controller enter into Network mode / Analog mode	
4. Device List	Display the added camera information	
5. Type: Static / Dynamic	Network Type	Switch the joystick left and right, [Enter] confirm
	DHCP	Dynamic allocation according to the switch
	Static	Need to set in IP, gateway, subnet mask
6. System Language: EN/CH	Switch the joystick left and right , [Enter] button to confirm	
7. Button Touch-tone	Switch the joystick left and right , [Enter] button to confirm	
8. Reset	Press [Enter] twice to enter recovery , [Esc] to cancel	
9. System Infomation	Display version number, local network parameters	
10. VISCA Return code Enable / Disable	Switch the joystick left and right , [Enter] button to confirm	

3.2 Description of Rotary Joystick

Operate	Output	Operate	Output	Operate	Output
	Up		Down		Left
Operate	Output	Operate	Output	Operate	Output
	Right		Zoom +		Zoom -

Joystick [Up, Down, Left, Right] : Control the PTZ to turn up , down , left and right.

Joystick [rotate left and right] : Rotate the joystick to zoom function , rotate right to zoom + , zoom

4. Controller Connection & Control Device

- >255 Cameras respectively adopt RS485 Pelco protocol
- > 7 Cameras respectively provided by Visca via RS422 group
- > 255 Cameras adopt Visca Over IP protocol respectively
- > A total of 255 cameras are controlled bycross-protocol mixing

> Add Network Camera

- (1) Press the enter button to enter the cameras ID
- (2) Set to select IP Visca(Onvif, Sony Visca)protocol
- (3) Press [Enter] button to save(After input enter)
- (4) Enter the IP address of the camera
- (5) Enter port number
- (6) Enter camera username, password
- (7) IP Visca (Sony Visca) protocol does not need to input camera username, password

Port: IP control port

Sony Visca defaults to 52381

IP Visca defaults to 1259

ONVIF default to 2000 or 80

If you have multiple Visca Over IP cameras different manufactures, you may have to set different

> Network mode connection diagram

The controller and PTZ camera are connected in the same LAN , and the IP addresses are in the same network segment , such as : 192.168.1.123 and 192.168.1.111.

Belong to the same network segment ; If not in the same LAN , you need to modify the IP address of the controller or camera at first , the default IP acquisition method of the controller is get it dynamicalu.

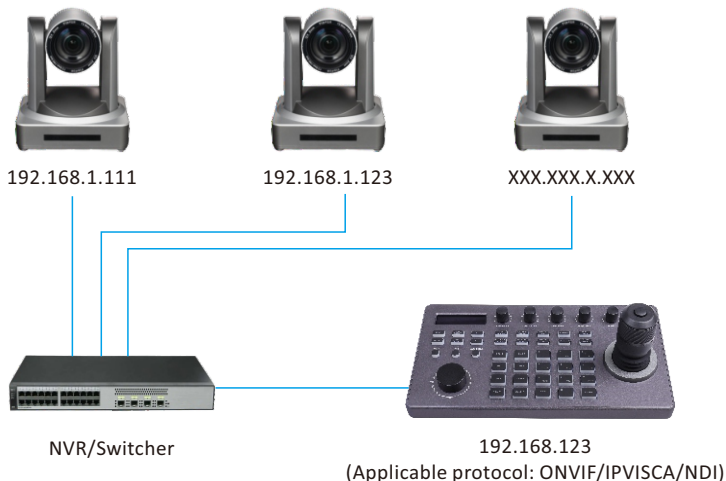

> Add Analog Camera

- (1) Press the confirm button to enter the camera ID , set to select the Visca (Pelco D/P) protocol , press the [Enter] button to save ;
- (2) Enter the camera address code , press [Enter] button to save ;
- (3) Input camera baud rate , press [Enter] button to save ;
- (4) Input serial port ID , press [Enter] button to save ;

> Analog Mode Connection Diagram

(1) Analog Mode RS232

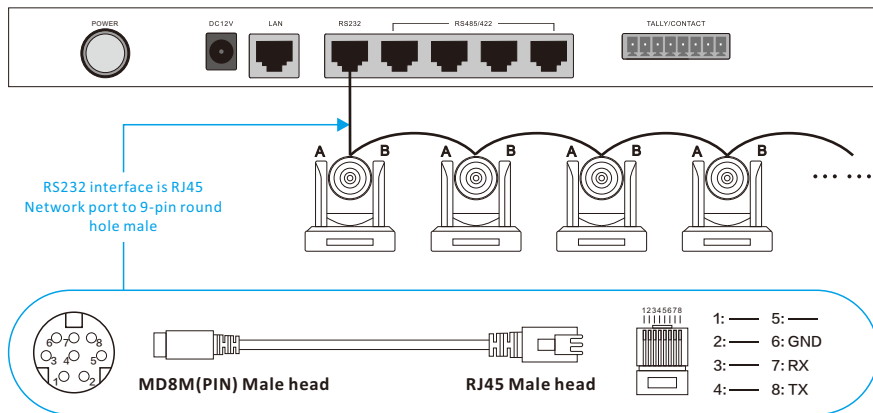

(2) Analog Mode RS485/RS422

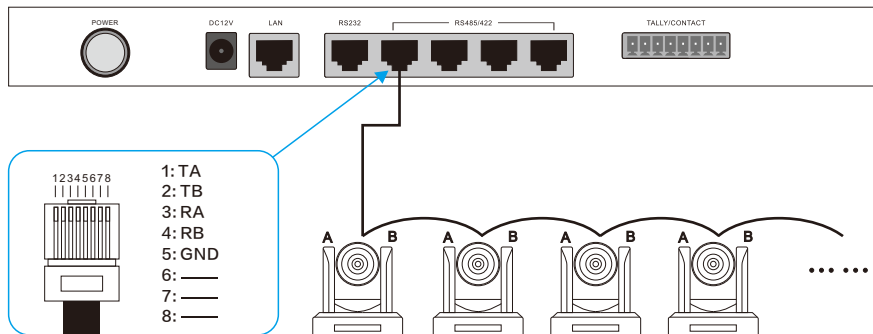

5. Network Configuration

5.1 First connection and login

The controller and PTZ camera are connected in the same LAN , and the IP addresses are in the same network segment , such as : 192.168.1.123 and 192.168.1.111.

Belong to the same network segment ; If not in the same LAN , you need to modify the IP address of the controller or camera at first , the default IP acquisition method of the controller is get it dynamically.



(2) After entering the device web UI, the page is displayed as shown below.

Device Management		Settings						
Search Device								
Add Manually								
	Channel	IP	Port	Protocol(network)	Baudrate	Address	Protocol(analog)	Operate
<input type="checkbox"/>	1	192.168.1.132	1259	VISCA(UDP)	9600	1	PELCO-D	
<input type="checkbox"/>	2	192.168.1.132	80	ONVIF	9600	2	PELCO-D	
<input type="checkbox"/>	3	192.168.5.170	80	ONVIF	9600	3	PELCO-D	
<input type="checkbox"/>	4	192.168.5.170	80	ONVIF	9600	4	PELCO-D	
<input type="checkbox"/>	5	192.168.5.170	80	ONVIF	9600	5	PELCO-D	

(3) After entering the homepage of the device , you can view the details of the device parameters and change them.

(4) Click the [] button to add and modify device parameters in the LAN , the page is displayed as follows.

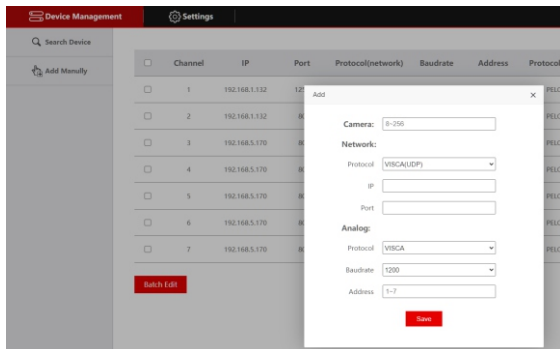

(Enter device number , corresponding IP address , port number and username click save.)

Notice:

When entering the controller web and add device successfully is synchronized with controller , in the web page adds the device successfully then click the controller corresponding to the number to control the dome camera.

5.2 Web UI Network Setting

The LAN settings can modify the IP acquisition method and port parameters of the device , as below picture shown;

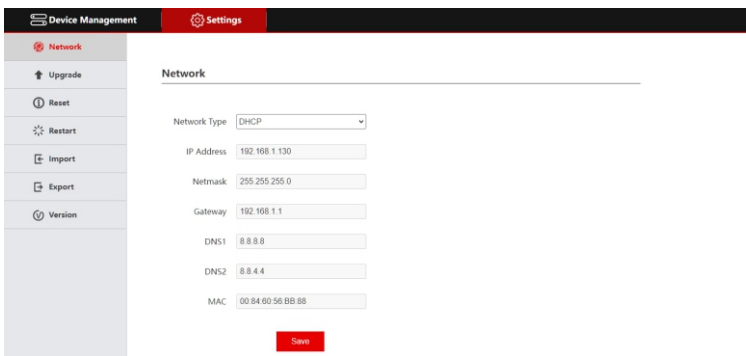

Static address (Static) : When the user needs to set network segment by himself , change the network type to a static address , and fill in the network segment information to be modified.

Dynamic address (DHCP) (default acquisition method) : The controller will automatically request an IP address from the router. After the request is successful , it will be displayed on the display screen of the controller. The displayed format is "Local IP : XXX,XXX,XXX,XXX".

5.3 System Upgrade

The upgrade function is used as a maintenance and update controller function . After entering the upgrade page , select the correct upgrade file and click [Start] .

Ps: Do not perform any operations on the device the upgrade process , and do not cut off the power or network!

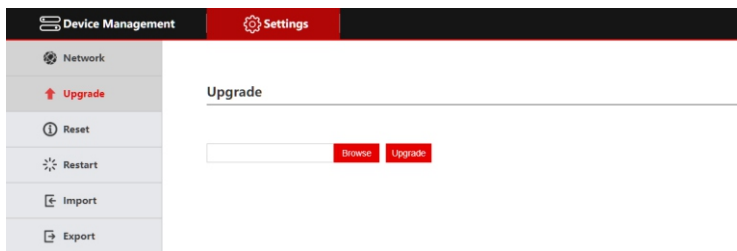

5.4 System Reset

When clicking Device Reset , the controller will delete the configuration information and clear the added devices .

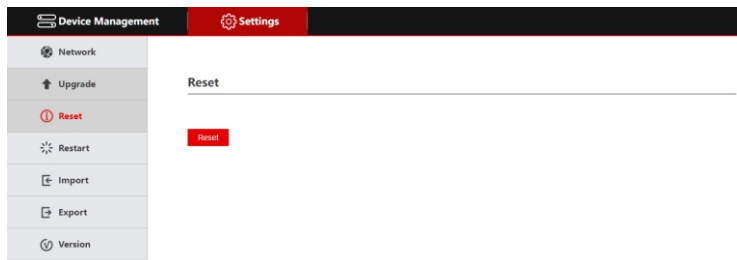

5.5 Restart

When the device has been running for a long time and needs to be restarted for maintenance, click Restart to achieve the purpose of restarting maintenance

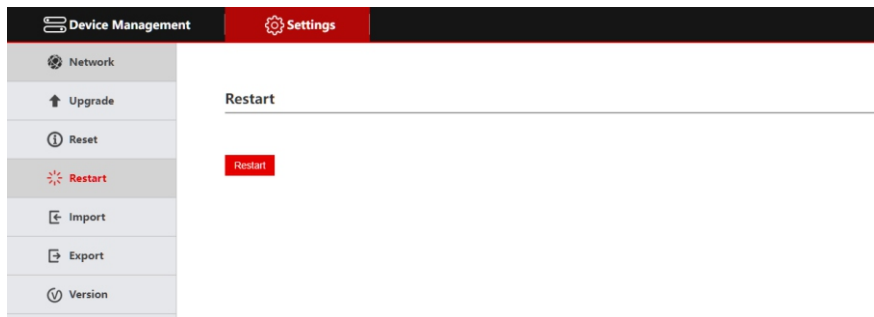

5.6 Import Configuration

Import the device information of the previous controller , (for example , when adding multiple devices to the previous controller , export the file type , and use it as an import to another device when adding a new controller.)

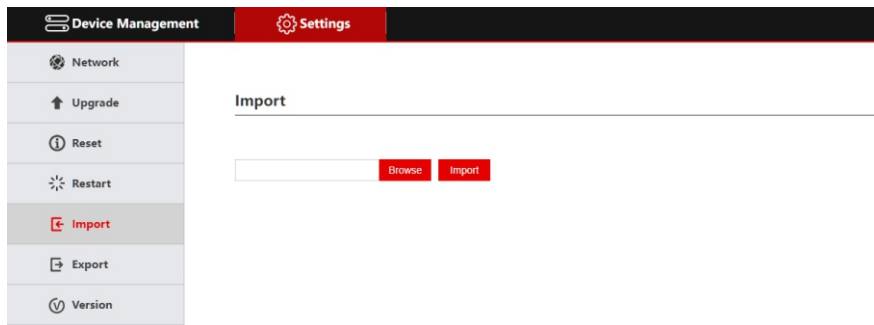

5.7 Export information

Export information about adding multiple devices to the current controller , which can be exported to other controller devices for use.

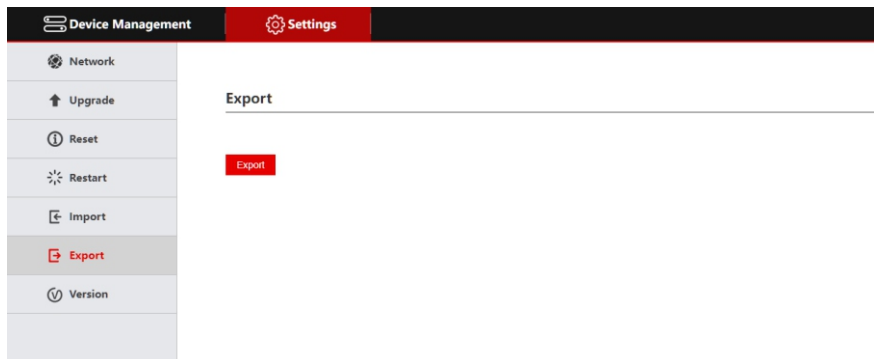

The screenshot shows the 'Settings' page under 'Device Management'. The left sidebar contains a menu with the following items: Network, Upgrade, Reset, Restart, Import, Export (highlighted in red), and Version. The main content area is titled 'Export' and contains a single red button labeled 'Export'.

5.8 Version Information

Display the hardware and software information of the current controller.

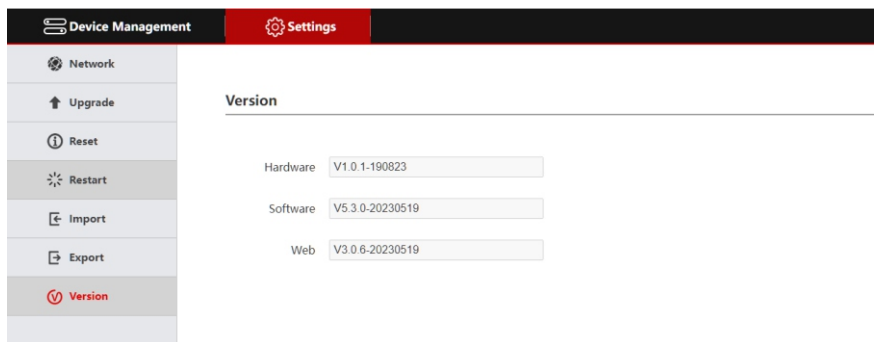

The screenshot shows the 'Settings' page under 'Device Management'. The left sidebar contains a menu with the following items: Network, Upgrade, Reset, Restart, Import, Export, and Version (highlighted in red). The main content area is titled 'Version' and displays three rows of information:

Hardware	V1.0.1-190823
Software	V5.3.0-20230519
Web	V3.0.6-20230519

6. FQA

1. When the screen displays "Connection Failed" , please check whether the device corresponding to this IP is connected normally in the LAN.
2. When the screen displays" Username password error " , please check whether the username and password of the added device are correct.
3. When adding another brand of equipment using the ONVIF protocol fails , check whether the camera has enabled the ONVIF protocol of the device.

- NOTE:**
1. Adding devices is manual.
 2. Enter the correct port number and device connection protocol in Add Device .